

RECTANGLE

100.16

PRODUCT SPECIFICATION

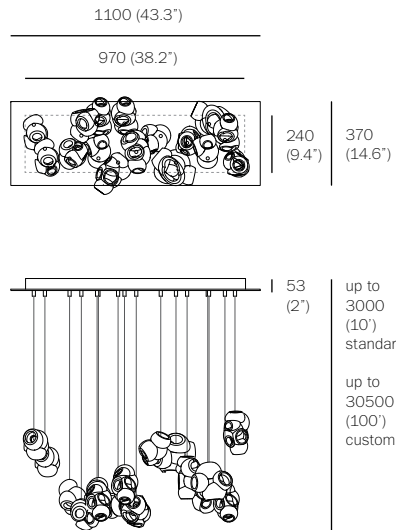

150-191
(5.5'-7.5')

- PENDANTS: sixteen
- MOUNTING: white powder coated rectangular canopy 1100mm (43.3') x 370mm (14.6") x 53mm (2") deep
- LAMPING: 1.5w LED (2000K, 2500K, 3500K)
- COAX: fixed lengths. 3000mm (10') standard / up to 30500mm (100') maximum
- MATERIALS: blown glass, braided metal coaxial cable, electrical components, white powder coated canopy
- WEIGHT: approximately 54.2kg (119.5lb)
- POWER SUPPLIES: integral

DESCRIPTION

100.16 is a random configuration of sixteen 100 pendants hung from a rectangular canopy. The drop lengths of the pendants are randomized between a client specified range of heights to variously cluster and scatter. The result is an ambient installation or field of light.

100 brings multiple glass artists together in a performative act. Molten glass bubbles are prepared and then smashed together to produce unpredictable interlocking glass forms.

NOTES

- + Purchase replacement lamps online at www.bocci.com/shop/bulbs
- + All chandeliers will be outfitted with 2500K lamps if not specified.
- + As an alternative to a built-in power supply, Bocci recommends mounting Power supplies remotely in an easily accessible and hidden location for ease of long-term maintenance.

US Patent Pending
EU Patent # 008526131-0001

Made in Vancouver, Canada

Vancouver
sales@bocci.com
www.bocci.com

Berlin
europe@bocci.com
www.bocci.com

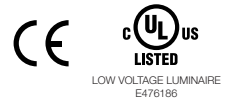

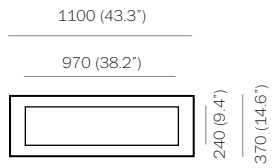

1

Note: All connections and power supplies are tested by our technicians before shipping. However, it is possible for ports/power supplies to come loose or damage during shipping.

Test each port before installing canopy to ceiling to catch any loose connections or faulty power supplies.

Measure and mark the light fixture canopy position on the ceiling

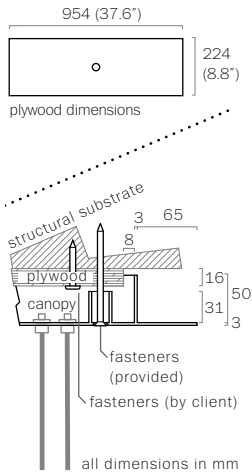

2

Note: The client is responsible for providing a robust 16mm (5/8") plywood backing or wood blocking to securely anchor to the structural substrate.

Connections from the plywood to the structural substrate are the client's responsibility.

Measure the plywood so that it fits within the canopy side walls (refer to detail above).

Anchor the plywood backing to the structural ceiling substrate.

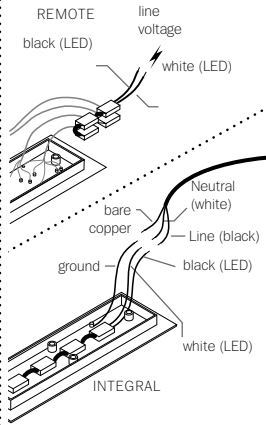

3

Connect power supplies to line voltage.

Connect the black wire to black and white wire to white wire.

For the ground connection, connect the green wire with yellow stripe to the bare copper wire or green wire in the junction box.

Note: Bocci strongly recommends mounting power supplies remotely in a close, accessible and hidden location for ease of long term maintenance. Installation to be done by certified personnel to ensure compliance with the code.

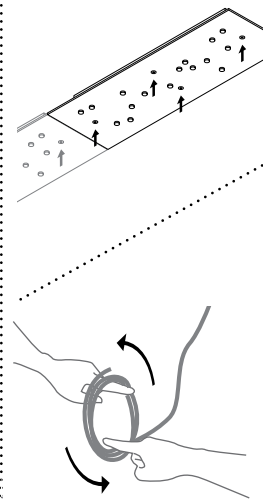

4

Anchor canopy into the plywood backing using the fasteners provided.

Turn power to fixture on.

Very carefully uncoil the braided coaxial cable in a spool like manner. Insert your index fingers into opposite sides of the roll then rotate your fingers around each other to unroll the coaxial cable.

Use patience: allow the cable to uncoil completely to avoid kinks.

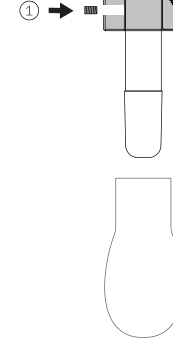

5

Step 1: Attach the lamp holder to the pendant hardware with set screw provided.

Plug the lamp into lamp holder and slide on the diffuser. Do not touch the lamp with your bare hands. Ensure power to lamp is working correctly.

6

Each pendant terminates in a "headphone jack" type connector, which plugs into a receiving receptacle in the canopy. Clients are encouraged to compose their own pendant configuration on site, thus creating a truly unique fixture. After plugging in each pendant, turn the threaded sheath into place by hand ensuring that it is adequately tightened. Tools are not required.

Check that each lamp is working properly as you go along by keeping power to the fixture on and lamps plugged in.

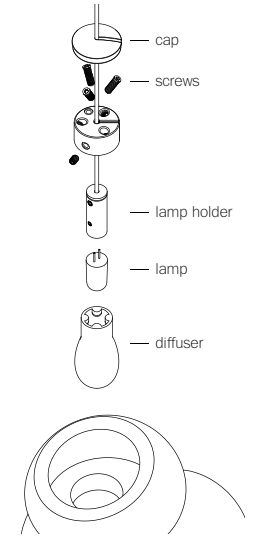

7

Please note that the crisp cut edges of the 100 pendants are fragile and can chip if not handled with care when installing and cleaning.

Please ensure they do not have impact during hanging. Best practice is to install from one side of the fixture to the other.

Bocci recommends wearing gloves during the installation. The edges of the glass may be sharp to handle.

RECTANGLE

100.16

PRODUCT INSTALLATION INSTRUCTIONS

© 2021, Bocci Design and Manufacturing Inc. All rights reserved. Any inquiries should be directed to: info@bocci.com

BOCCI

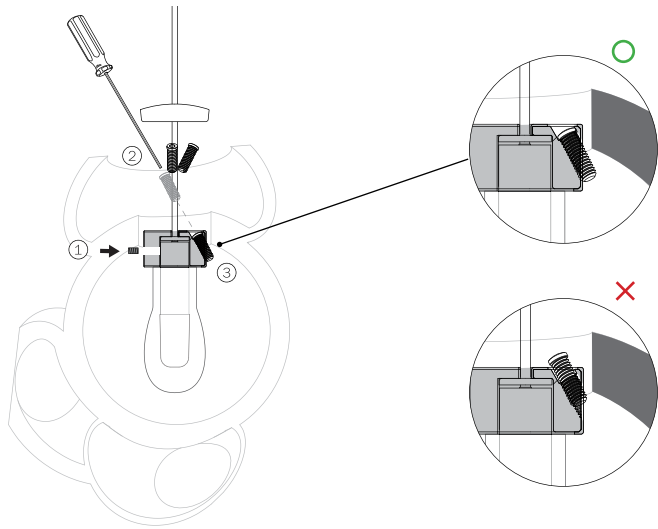

8

Step 2: Insert the pendant hardware assembly into the pendant.

Step 3: Tighten the 3 screws until they are fully engaged (refer to illustration above).

9

Give the pendant a gentle pull to ensure the screws are locked onto the pendant.

Slide cover cap onto the coaxial cable and place into the inset portion of the pendant hardware.

10

The cap should sit flat on the pendant hardware.

If the screws are sticking out and the cap isn't sitting flat on the pendant hardware, please check to ensure the screws are fully engaged.

Refer to step 8 & 9 for more details.

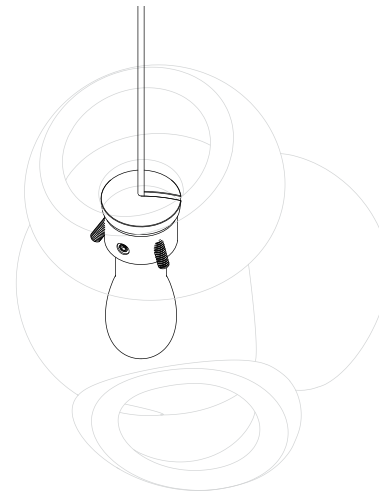

11

Clean fingerprints from surfaces.

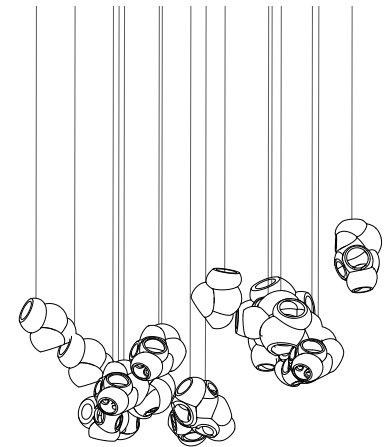

For additional assistance,
please contact Bocci:

Vancouver
sales@bocci.com
www.bocci.com

Berlin
europe@bocci.com
www.bocci.com

US Patent Pending
EU Patent # 008526131-0001

Made in Vancouver, Canada



RECTANGLE

100.16

PRODUCT INSTALLATION INSTRUCTIONS

© 2021, Bocci Design and Manufacturing Inc. All rights reserved. Any inquiries should be directed to: info@bocci.com

BOCCI